



Product	Nominal torque (x)	Self-holding torque (energized)	Nominal rated speed
PSW 301-8	1 Nm	0.5 Nm	180 min ⁻¹
PSW 302-8	2 Nm	1 Nm	100 min ⁻¹
PSW 305-8	5 Nm	2.5 Nm	35 min ⁻¹

Duty cycle	20% (basis time 600s) at nominal torque
Mode of operation	S3
Supply voltage	24 VDC ± 10% galvanically separated between control and motor and bus
Nominal current	2.3 A
Power consumption (control unit)	0.1 A
Positioning accuracy absolute measurement of position taken directly at the output shaft	0.9°
Positioning range	250 rotations not subject to mechanical limits
Shock resistance in accordance with IEC/DIN EN 60068-2-27	50g 11 ms
Vibration resistance in accordance with IEC/DIN EN 60068-2-6	10..55 Hz 1.5 mm/ 55..1 000 Hz 10g/ 10..2 000 Hz 5g
Output shaft	8 mm solid shaft or 8 mm hollow shaft with clamp ring
Max. axial force	20 N
Max. radial force	40 N
Ambient temperature	0..45 °C
Storage temperature	-10..70 °C
Protection class	IP68 at standstill, IP66 during rotation
Material	stainless steel
Weight	1550 g
Certificates	CE/UKCA, optional: NRTL, optional: STO with/without test pulses ¹⁾

¹⁾ STO: only for EtherCAT, EtherNet/IP, POWERLINK, PROFINET, without galvanic separation of the supply voltage

PSW 30x-8 (with hollow shaft)

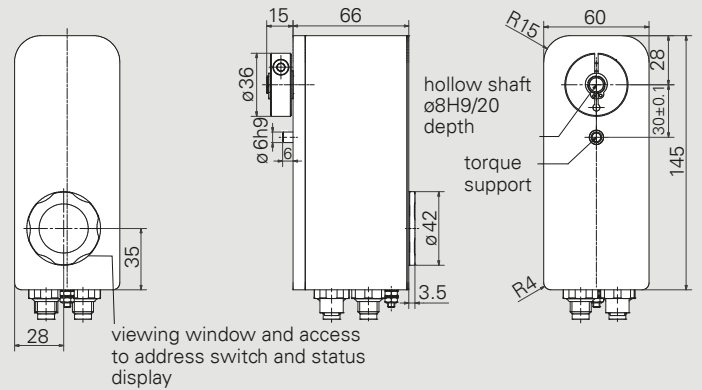

PSW 30x-8 V (with solid shaft)

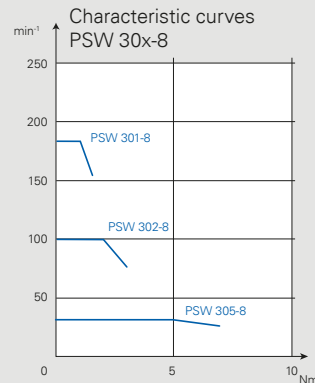
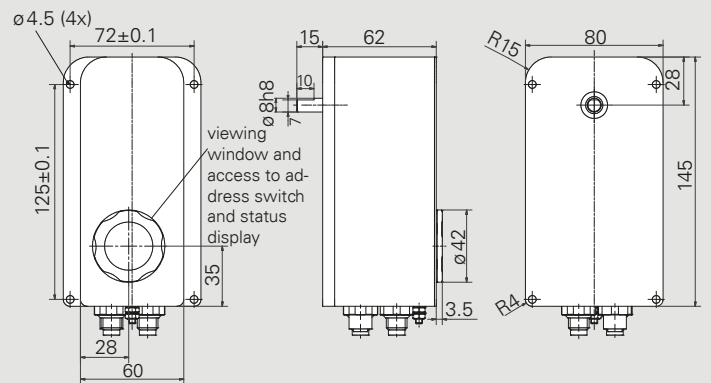

Dimensions in mm. For details of the connections please see also the instruction manual.



How to choose your suitable positioning system?



To order our standard products, you can use the graphics on the right for an initial performance assessment of the products and the corresponding order code of the 3 series. The ordering process is described below using an example.

- A** Choose the appropriate **design** based on your operating conditions
- B** **Type:**
 - Vertical or horizontal form (value even or odd)
 - max. rated torque (x) - for orientation see characteristic diagrams
 - Output shaft (8 or 14) and solid or hollow shaft
- C** select required protocol / interface (**bus communication**)
- D** integrate the **connections** that are essential for you
- E** if necessary, select a **brake** (without brake select 0)
- F** select required **certificates**
- G** select **IP protection class**

For example, a stainless steel housing (PSS), the 30x design, a maximum rated torque of 2 Nm and an 8 hollow shaft would be required (302-8). Besides IO-Link, the standard connections are required, no brake, the CE/UKCA certificate and IP65.

→ Order code **PSS 302-8-IO-0-0-0-65**

Torques and speeds

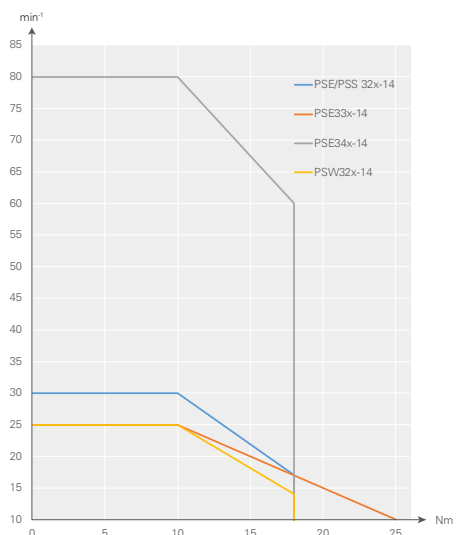
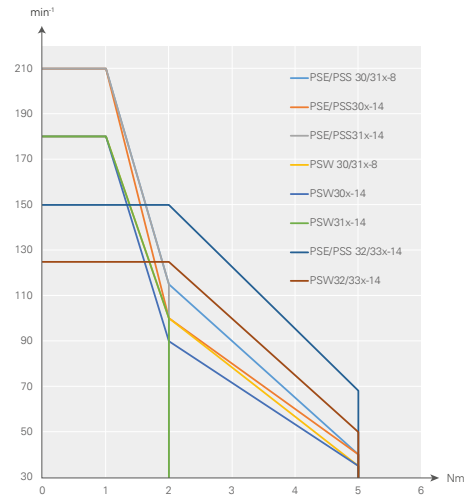



Order code PSE/PSS/PSW 3 series



	A Design	B Type	C Bus communication	D Connections	E Brake	F Certification	G IP protection class
Positioning System Efficient	PSE	30x-8 30x-8 V 30x-14 31x-8 31x-8 V	CA: CANopen DP: PROFIBUS DP DN: DeviceNet ¹⁾ MB: Modbus RTU ¹⁾	0: Standard ²⁾ T: Standard with jog keys ¹⁾ X: Plug-in, L-coded ¹⁾	0: without M: with ³⁾	0: CE / UKCA N: NRTL + CE / UKCA S: STO + CE / UKCA without test pulses ¹⁾ T: STO + CE / UKCA with test pulses ¹⁾	54: IP 54 ¹⁾ 65: IP 65 ¹⁾ 68: IP 68 ⁴⁾
Positioning System Stainless	PSS	31x-14 31x-14 V 32x-14 32x-14 V	SE: Sercos EC: EtherCAT PN: PROFINET EI: EtherNet/IP	Y: Plug-in, Y-coded ¹⁾ Z: Plug-in, Y-coded, with jog keys ¹⁾		Y: STO + NRTL + CE / UKCA without test pulses ¹⁾ Z: STO + NRTL + CE / UKCA with test pulses ¹⁾	
Positioning System Washable	PSW	33x-14 33x-14 V 34x-14 ⁵⁾	PL: POWERLINK IO: IO-Link				

Form/Type	Torque	Output shaft
30	x = 1 Nm	8 = 8 mm hollow shaft 14 = 14 mm hollow shaft
31	x = 2 Nm	
32	x = 5 Nm	8 V = 8 mm solid shaft ¹⁾ 14 V = 14 mm solid shaft ¹⁾
33	x = 10 Nm	
34	x = 18 Nm	
	x = 25 Nm ⁵⁾	



To place your order, please call us at
+49 7661 3963-0 or email us at
info@halstrup-walcher.com.
 For additional contacts, please visit
www.halstrup-walcher.de/en/contact









¹⁾ Not available as standard for all versions / bus communication. Please contact our sales department.
²⁾ The standard is 3 plugs / sockets (except for IO-Link or Y-coded connector)
³⁾ only for variants with 14 mm output shafts
⁴⁾ only for PSW
⁵⁾ only for PSE

Please refer to the data sheets for the respective standard combinations.



Accessories for our positioning systems

The connectors shown here can be used for all 3 device types (PSE / PSS / PSW). For PSE (IP 54/IP 65) and PSS (IP 65), this ensures the IP protection classes. If required, we are happy to help you find a suitable connector for a PSW (IP 68) - please contact us.

Buscommunication	Power supply (+ databus connector) (for option 0) ¹⁾	Power supply + databus + jog key connector	Cable
CANopen	 <p>Connector set: Order no. 9601.0060</p>	 <p>Connector set: Order no. 9601.0062</p>	
PROFIBUS DP			
Modbus RTU			
DeviceNet	 <p>Connector set: Order no. 9601.0088</p>	 <p>Connector set: Order no. 9601.0090</p>	<p>On request</p> 
Sercos	 <p>Connector set: Order no. 9601.0112</p>	 <p>Connector set: Order no. 9601.0317</p>	
EtherCAT			
PROFINET			
EtherNet/IP			
POWERLINK			
IO-Link	 <p>Connector: Order no. 9601.0107</p>		

¹⁾ see in order code under D

Screw cap to cover the second bus connection
(for PSS/PSW)

Order no. 9601.0176



Jog key box
(for Option T in section D of the Order code)

Order no. 9601.0241

Software

Use our function blocks, description files or commissioning tools for the various industrial protocols. You can download the files under www.halstrup-walcher.de/en/software. To do this, enter your specific product in the drop-down menu that appears and select the Software tab in the tab view. After that, the software components are available to you.

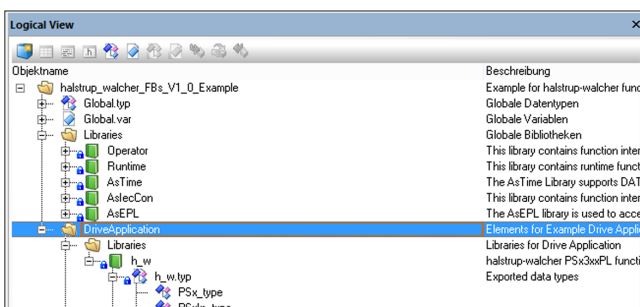

You want to see our products in person?

We are represented at numerous trade fairs and will be happy to advise you. Visit us on site and let us find the ideal solution together. You can find our current exhibition dates and product news at:



www.halstrup-walcher.de/en/news/