

---

## Instruction Manual PSE4xxDP

---



halstrup-walcher GmbH

Stegener Straße 10  
D-79199 Kirchzarten  
Germany

Phone: +49 (0) 76 61/39 63-0  
Fax: +49 (0) 76 61/39 63-99

E-Mail: [info@halstrup-walcher.com](mailto:info@halstrup-walcher.com)  
Internet: [www.halstrup-walcher.com](http://www.halstrup-walcher.com)

## Table of Contents

1 Safety precautions.....	5
1.1 Appropriate use.....	5
1.2 Shipping, assembly, electrical connections and startup.....	5
1.3 Troubleshooting, maintenance, repairs, disposal.....	5
1.4 Symbols .....	6
2 Instrument description .....	7
2.1 Features.....	7
2.2 Mounting .....	8
2.3 Pin assignment .....	8
2.4 Start-up .....	9
2.5 DP address .....	9
2.6 Sequence of positioning steps.....	9
2.7 Running a reference loop .....	9
2.8 Operating without a reference loop .....	10
2.9 Assigning an actual position.....	10
3 Configuration.....	11
3.1 Status byte .....	12
3.2 Actual position.....	16
3.3 Command byte.....	17
3.4 Target position .....	18
4 Setting parameters .....	19
4.1 Direction of rotation: .....	19
4.2 Direction of travel: .....	19
4.3 Block mode: .....	19
4.4 Positioning window.....	20
4.5 Acceleration: .....	20
4.6 Max. motor current: .....	20
4.7 Lower limit switch: .....	20
4.8 Upper limit switch: .....	20
4.9 Operating current: .....	20
4.10 Holding current:.....	21

4.11 Idle period: .....	21
4.12 Spindle pitch: .....	21
4.13 Max. speed: .....	21
4.14 Starting speed: .....	21
5 Programming tips .....	22
6 Technical data .....	23
8 Dimension drawings .....	31

## Purpose of instruction manual

This instruction manual describes the features of the PSE 4xxDP positioning system and provides guidelines for its use.

Improper use of these instruments or failure to follow these instructions may cause injury or equipment damage. All individuals responsible for operating these instruments must therefore be properly trained and aware of the hazards, and must carefully follow these operating instructions and the safety precautions detailed within. **Contact the manufacturer if you do not understand any part of this instruction manual.**

Handle this manual with care:

- It must be readily available throughout the lifecycle of the instruments.
- It must be provided to any individuals who assume responsibility for operating the instrument at a later date.
- It must include any supplementary materials provided by the manufacturer.

The manufacturer reserves the right to continue developing this instrument model without documenting such development in each individual case. The manufacturer will be happy to determine whether this manual is up-to-date.

## Conformity

This instrument corresponds to the state of the art and meets all legal requirements set forth in EC directives as evidenced by the CE label.



© 2005

The manufacturer owns the copyright to this instruction manual. This manual contains data, instructions and drawings pertaining to the features and usage of these instruments; copying this manual in part or in full or distributing it to third parties is prohibited.

# 1 Safety precautions

## 1.1 Appropriate use

Positioning systems are especially suitable for automatically setting tools, stops or spindles for wood-processing equipment, packing lines, printing equipment, filling units and other types of machines.

**PSE 4xxDP positioners are not stand-alone instruments and may only be used if coupled to another machine.**

Always observe the operating requirements—particularly the permissible supply voltage—indicated on the rating plate and in the "Technical data" section of this manual.

The instrument may only be handled as indicated in this manual. Modifications to the instrument are prohibited. The manufacturer is not liable for damages caused by improper use or failure to follow these instructions. Violations of this type render all warranty claims null and void.

## 1.2 Shipping, assembly, electrical connections and startup

Only technical personnel who are appropriately trained and authorized by the operator of the facility may assemble the instrument and set up its electrical connections.

The instrument may only be operated by appropriately trained individuals who have been authorized by the operator of the facility.

Specific safety precautions are given in individual sections of this manual.

## 1.3 Troubleshooting, maintenance, repairs, disposal

The individual responsible for the electrical connections must be notified immediately if the instrument is damaged or if errors occur.

This individual must take the instrument out of service until the error has been corrected and ensure that it cannot be used unintentionally.

This instrument requires no maintenance.

Only the manufacturer may perform repairs that require the housing to be opened.

The electronic components of the instrument contain environmentally hazardous materials and materials that can be reused. For this reason the instrument must be recycled in accordance with the environmental guidelines of the jurisdiction in question once it has been taken permanently out of service.

## 1.4 Symbols

The symbols given below are used throughout this manual to indicate instances when improper operation could result in the following hazards:



**WARNING!** This warns you of a potential hazard that could lead to bodily injury up to and including death if the corresponding instructions are not followed.



**WARNING:** This warns you of a potential hazard that could lead to significant property damage if corresponding instructions are not followed.



**INFORMATION** This indicates that the corresponding information is important for operating the instrument properly

## 2 Instrument description

### 2.1 Features

PSE 4xxDP positioning systems are intelligent, compact, complete solutions for positioning auxiliary and positioning axes, and consist of a stepping motor, gear power amplifier, control electronics and an absolute measuring system. The integrated absolute measuring system eliminates the need for a time-consuming reference run. Connecting to a bus system simplifies the wiring. A hollow shaft with adjustable collar makes assembly quite simple.

PSE4xxDP positioning systems convert a digital positioning signal into an angle of rotation.

#### PSE40xDP PSE41xDP

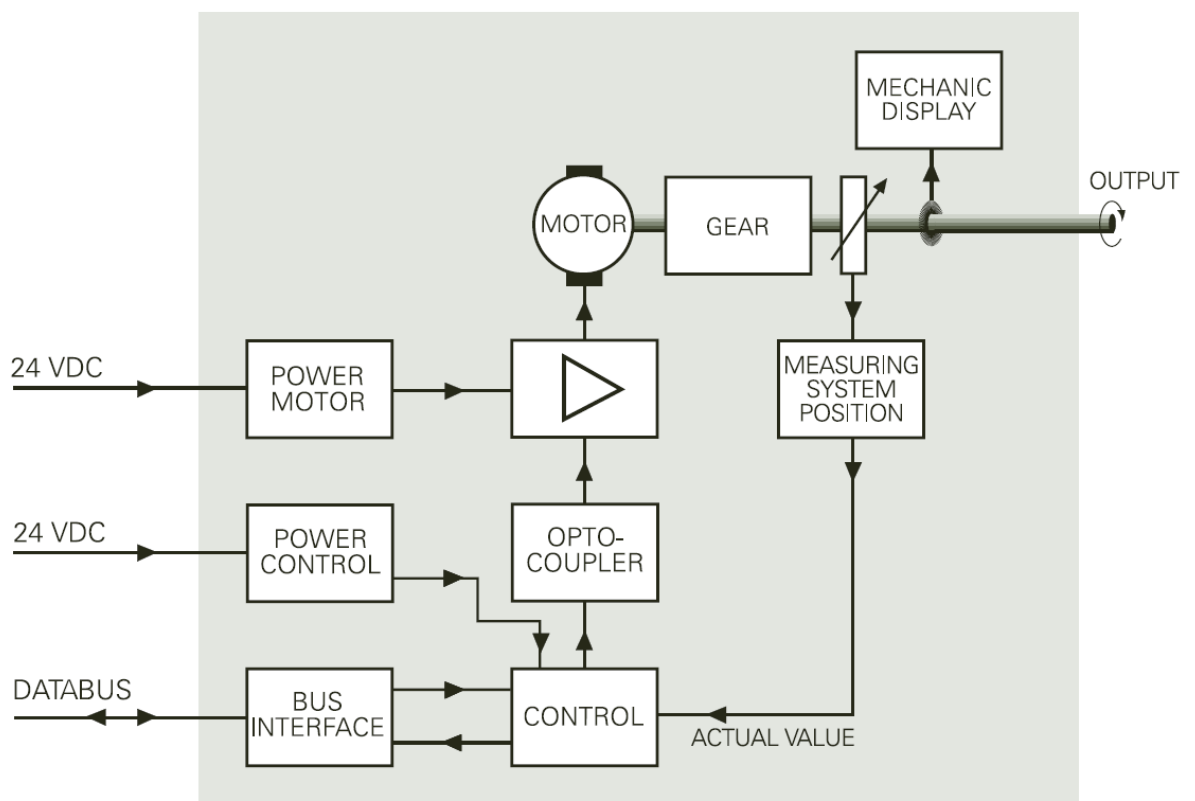

**PSE42xDP  
PSE43xDP**

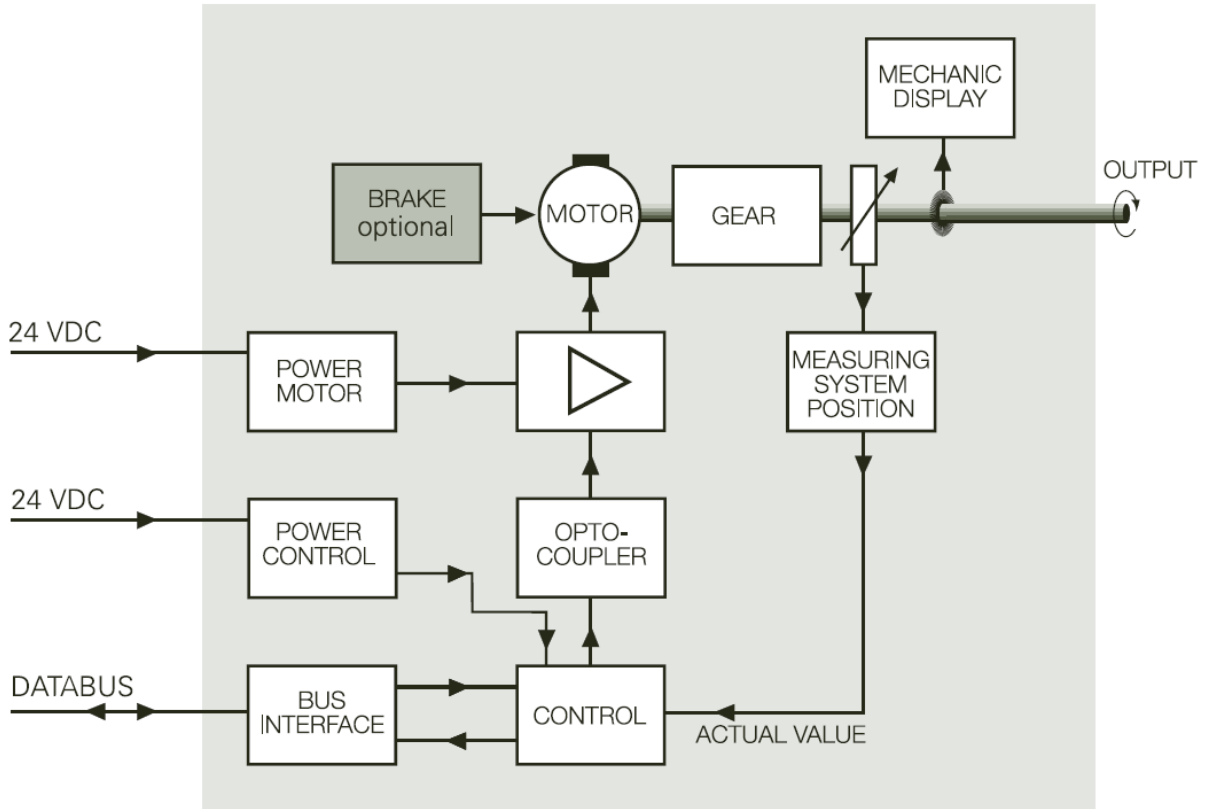

**2.2 Mounting**

The PSE 4xxDP is mounted onto the machine by sliding the hollow shaft of the positioning gear onto the axis to be driven and then securing it with an adjustable collar. The adjustable collar should be pretensioned just to the point where it can no longer rotate freely. Securing the pin under the hollow shaft into an appropriate bore will prevent further rotation (see drawing).



**Never apply force to the housing cover, e.g., for supporting weight**

**2.3 Pin assignment**

A round, 5-pin plug for the supply voltage and a round, 9-pin D-sub-socket for connecting the Profibus are located on the housing cover of the PSE 4xxDP.

**power supply**

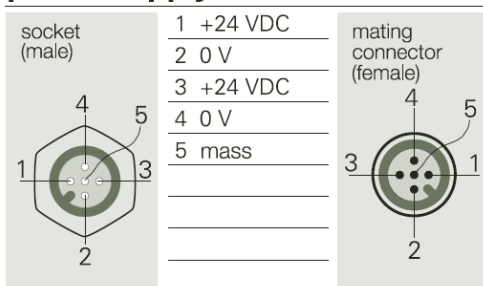

**Profibus (...-DP)**

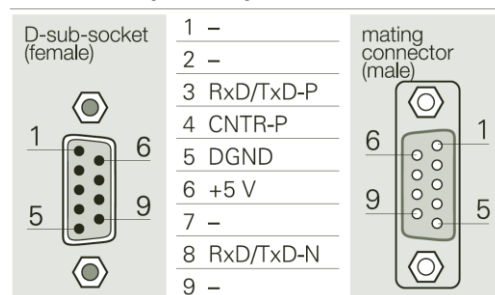



## 2.4 Start-up

After the supply voltage has been hooked up, the PSE 4xxDP should be run through an initial reference loop prior to positioning, i.e., the instrument should complete half of a reverse rotation and half of a forward rotation (or vice versa, depending on the settings).

The reference loop is triggered when the corresponding command byte is transferred across the interface.

## 2.5 DP address

Two rotary switches are used for setting the DP address; these are located below the black plate on the drive shaft cover. Settings are decimal, with the Low switch corresponding to the LSB and the High switch corresponding to the MSB. (LSB= Least Significant Bit; MSB= Most Significant Bit)

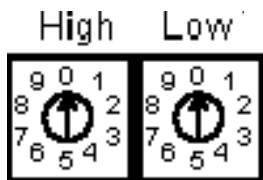

Example: 5      1      = a DP address of 51



**Important: Always replace the protective cap after setting the address. This will prevent dust and contaminants from entering the instrument.**

## 2.6 Sequence of positioning steps

The PSE 4xxDP distinguishes between the following steps of a positioning sequence. (It is assumed that all target positions are approached via forward motion.)

1. New position value is larger than the current value: position approached directly.
2. New position value is smaller than the current value: the instrument reverses one half of a rotation and approaches the exact position after resuming forward motion.
3. New position value after reverse run (no reference loop): the instrument always approaches the position by moving forward one half of one rotation; if necessary, it will then reverse by one half of a rotation.

The instrument checks the target position once it has been reached. If the actual position differs from the target, the instrument repeats the positioning process and sets the “Second positioning run required” status bit. If this second attempt also fails, it then sets the “positioning error” status bit.

## 2.7 Running a reference loop

In order for the PSE 4XX DP’s distance measuring system to determine its absolute position, the output shaft must complete half of one rotation. This means that the

instrument must ordinarily complete a reference loop every time the instrument is switched on or DP data transfer is activated. The software calculates the distance to the next half rotation, thereby minimizing this movement. For very small distances ( $< 1/50$  of a rotation), the instrument ignores the first position and uses the next position instead.

## **2.8 Operating without a reference loop**

Please keep in mind that gear backlash is not automatically eliminated if the drive is operated without a reference loop. An abbreviated reference loop, however, can easily be integrated into the programming. If operating without a reference loop, the value of the positioning window is multiplied by a factor of 2.

## **2.9 Assigning an actual position**

If a reference loop is not an option, a bit available in the command byte allows users to assign a target position as an actual position. The drive checks the assigned actual position using its internal distance measurement system and signals that it has accepted the new value by setting the “Loop OK” bit. If the instrument detects an overly large discrepancy, then it will set the “Positioning error” and “Invalid position” bits in the status byte. For this mode of operation, the control system must first note the position and then make the position available to the drive system. While this allows users to circumvent a reference run, it could lead to duplicate positions or positioning errors if the drive is moved while shut down, as the two positions will no longer agree.

### 3 Configuration

Configuring the system allows the user to determine the values that will be exchanged with the device being controlled during a run. The following list provides an overview of available options:

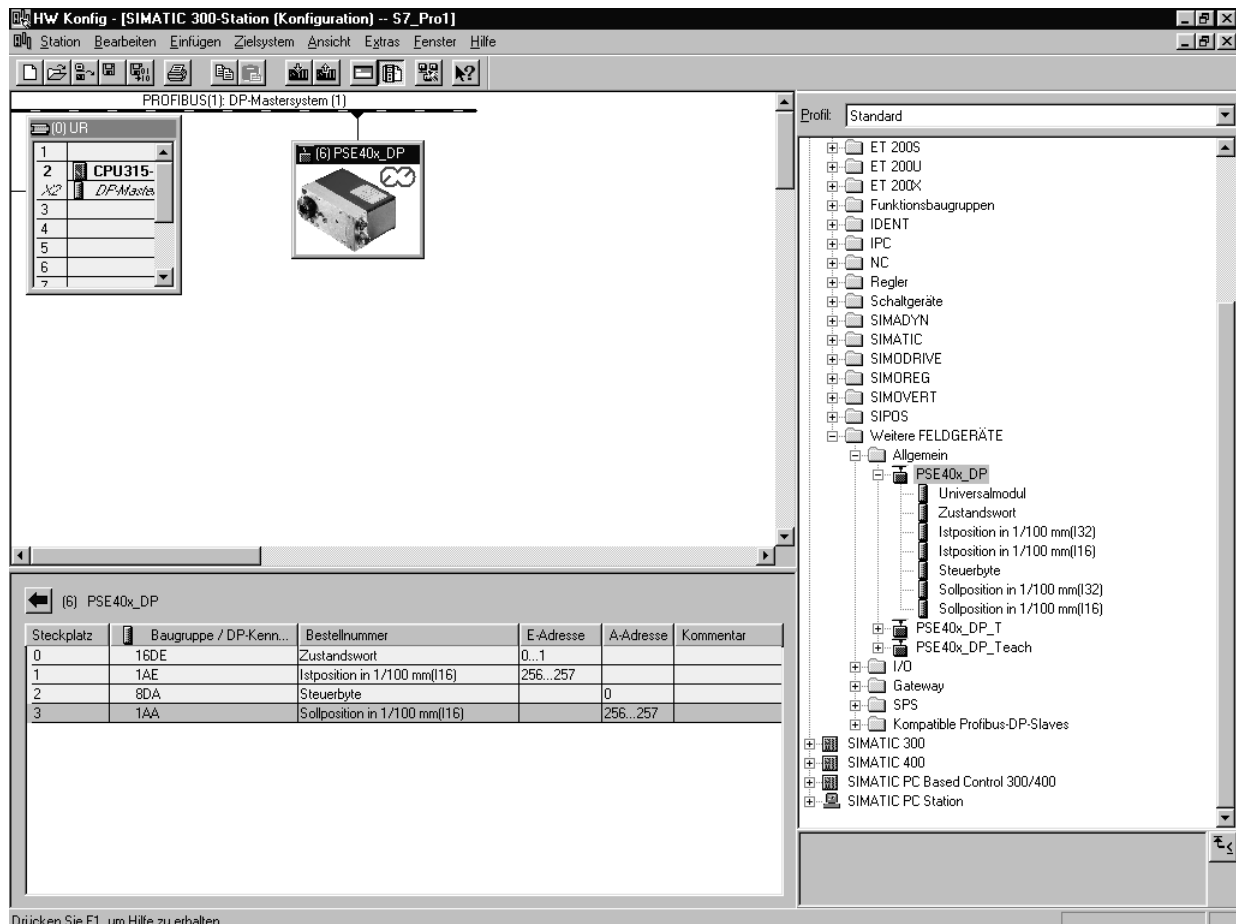

Normal operation requires only the status byte, the command byte, the target position and the actual position. Depending on the magnitude of the spindle pitch, 16 bit bytes are adequate for transferring target and actual values, thereby keeping the transfer time as short as possible.

The following describes the individual modules and data bits.

### 3.1 Status byte

The status byte indicates the instrument status. The following explains what individual bits within the status byte mean. The status byte is shown in black in the following table; input addresses depend on the user's system environment.

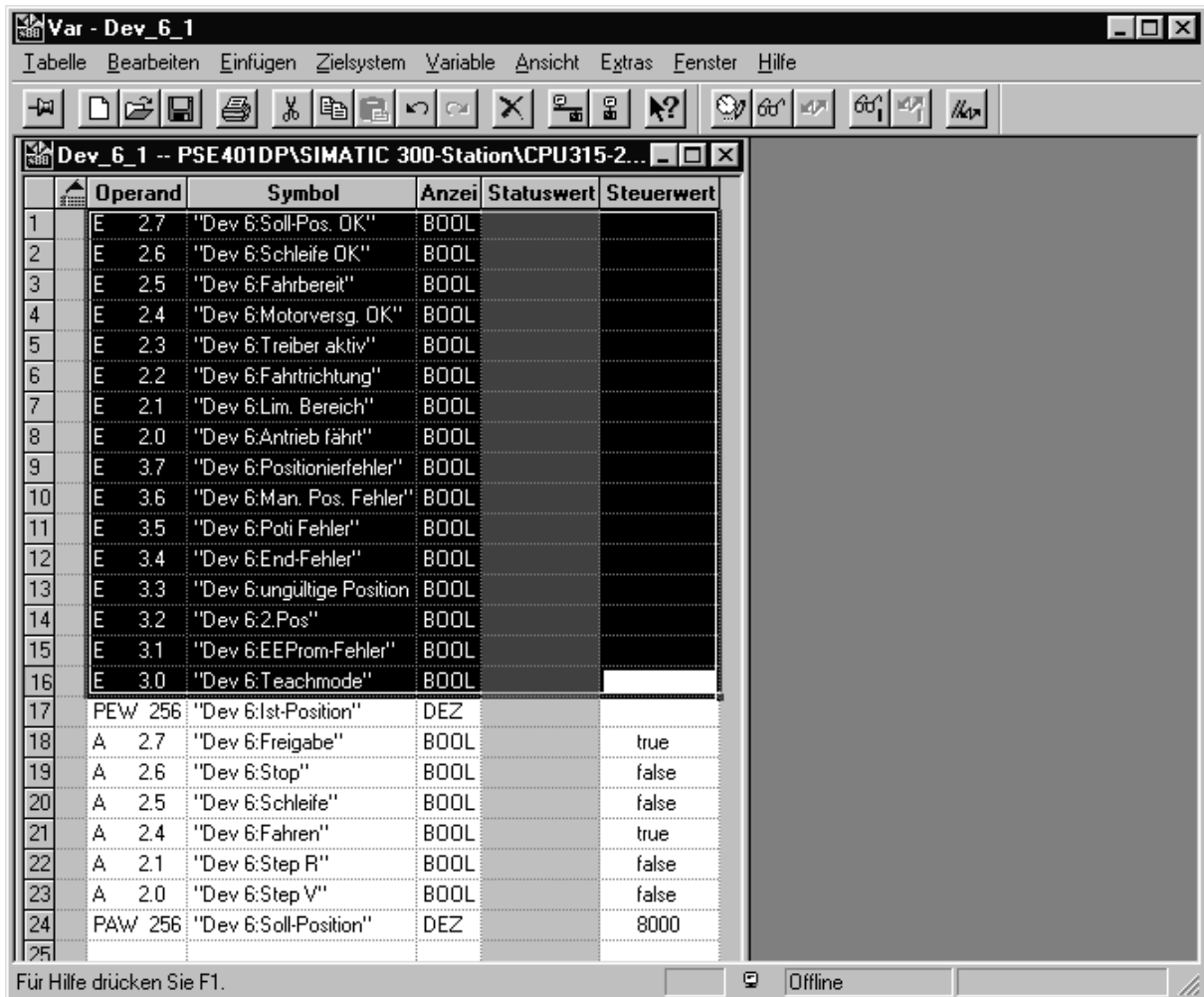

	Operand	Symbol	Anzei	Statuswert	Steuerwert
1	E 2.7	"Dev 6:Soll-Pos. OK"	BOOL		
2	E 2.6	"Dev 6:Schleife OK"	BOOL		
3	E 2.5	"Dev 6:Fahrbereit"	BOOL		
4	E 2.4	"Dev 6:Motorversg. OK"	BOOL		
5	E 2.3	"Dev 6:Treiber aktiv"	BOOL		
6	E 2.2	"Dev 6:Fahrtrichtung"	BOOL		
7	E 2.1	"Dev 6:Lim. Bereich"	BOOL		
8	E 2.0	"Dev 6:Antrieb fährt"	BOOL		
9	E 3.7	"Dev 6:Positionierfehler"	BOOL		
10	E 3.6	"Dev 6:Man. Pos. Fehler"	BOOL		
11	E 3.5	"Dev 6:Poti Fehler"	BOOL		
12	E 3.4	"Dev 6:End-Fehler"	BOOL		
13	E 3.3	"Dev 6:ungültige Position"	BOOL		
14	E 3.2	"Dev 6:2.Pos"	BOOL		
15	E 3.1	"Dev 6:EEProm-Fehler"	BOOL		
16	E 3.0	"Dev 6:Teachmode"	BOOL		
17	PEW 256	"Dev 6:Ist-Position"	DEZ		
18	A 2.7	"Dev 6:Freigabe"	BOOL		true
19	A 2.6	"Dev 6:Stop"	BOOL		false
20	A 2.5	"Dev 6:Schleife"	BOOL		false
21	A 2.4	"Dev 6:Fahren"	BOOL		true
22	A 2.1	"Dev 6:Step R"	BOOL		false
23	A 2.0	"Dev 6:Step V"	BOOL		false
24	PAW 256	"Dev 6:Soll-Position"	DEZ		8000
25					

**Bit 15(MSB):** Target pos. OK (target position reached)

This bit is set

- when a transferred target position has been reached successfully
- after running a reference loop, when the actual value corresponds to the previously transferred target value

This bit is deleted

- if target and actual positions do not agree
- if running individual increments

**Bit 14:** Loop OK

This bit is set

- after an initial reference loop has been successfully completed

This bit is deleted

- after the instrument is switched on
- if the drive is blocked during a positioning run

- if the drive is rotated manually when it is on standstill

**Bit 13: Ready**

This bit is set

- when all internal calculations have been completed and no more error messages are active

This bit is deleted

- after the instrument is switched on
- when error messages are active
- when internal calculations are still being performed

There is no need to check this bit during normal operation. The internal process control system ensures that run commands are not executed until after all calculations have been completed.

**Bit 12: Motor supply voltage OK**

This bit is set

- when the voltage to the motor is above a minimum level

This bit is deleted

- if the voltage to the motor is too low

**Bit 11: Driver active**

This bit is set

- when the motor control driver is switched on (holding current > 0)

This bit is deleted

- when the motor control driver is switched off (holding current = 0)

**Bit 10: Direction of travel**

This bit is set

- when the direction of rotation corresponds to the direction of travel. No additional reference loops will be performed at the end of the run.

This bit is deleted

- when the direction of rotation does not correspond to the direction of travel.

**Bit 9: Lim. range**

This bit is set

- when the target value is transferred as a 16 bit integer value. As a result, the instrument will no longer be able to reach all positions when the spindle pitch is greater than 4.00 mm/rotation.

This bit is deleted

- when the target value is transferred as a 32 bit integer value.

**Bit 8: Drive running**

This bit is set

- when the drive is in motion and can be used as a confirmation for the “Run” bit in the command byte. New target positions can, however, be transferred and activated during a run. The drive will stop briefly in this case and will then continue on to the new target position.

This bit is deleted

- when the drive is not moving and the run command has been reset.

**Bit 7: Positioning error**

This bit is set

- if during a run the current target position and the current actual position do not agree (e.g., if the path is blocked or the motor power supply fails). An optical encoder continuously monitors the current actual position. If the difference between this and the current target position is too large, the drive is stopped. “Loop OK” is deleted.
- if the positioning system was unable to perform the reference loop correctly
- if an invalid position was assigned to the actual position. The invalid position bit is also set in this case.

This bit is deleted

- during the reference loop

**Bit 6: Man. pos. error**

This bit is set

- if the drive is on standby yet the encoder detects that the drive is still rotating. This would result in a positioning error during the next run. “Loop OK” is deleted.

This bit is deleted

- during the reference loop

**Bit 5: Pot. error**

This bit is set

- if the absolute value encoder generates invalid values during the run. This could indicate a defect in the instrument.

This bit is deleted

- during the reference loop

**Bit 4: End error**

This bit is set

- if the drive comes to a stop outside of the valid positioning range. This can occur if the instrument has been rotated manually.

This bit is deleted

- during the reference loop and when operating within the permissible range.

**Bit 3: Invalid position**

This bit is set

- when a position is entered that lies outside of the valid range (the absolute positioning range and the range within the limit switches).

This bit is deleted

- by entering a valid position.

*Bit 2: 2<sup>nd</sup> pos. (second positioning)*

This bit is set

- when the target position is not achieved at the end of the run, but this error has not been caused by an obstacle. The drive then automatically performs a second positioning run.

This bit is deleted

- when the new positioning run is started.

*Bit 1: EEPROM error*

This bit is set

- when an error is detected when reading out the device-specific parameters. These parameters are used for the positioning system and are not related to the parameters set by the profibus.

This bit is deleted

- when the computer is restarted or
- during an adjustment run (may only be performed by the manufacturer or by trained personnel)

*Bit 0: Teach mode*

This bit is set

- when teach mode is active

This bit is deleted

- when teach mode is not active

### 3.2 Actual position

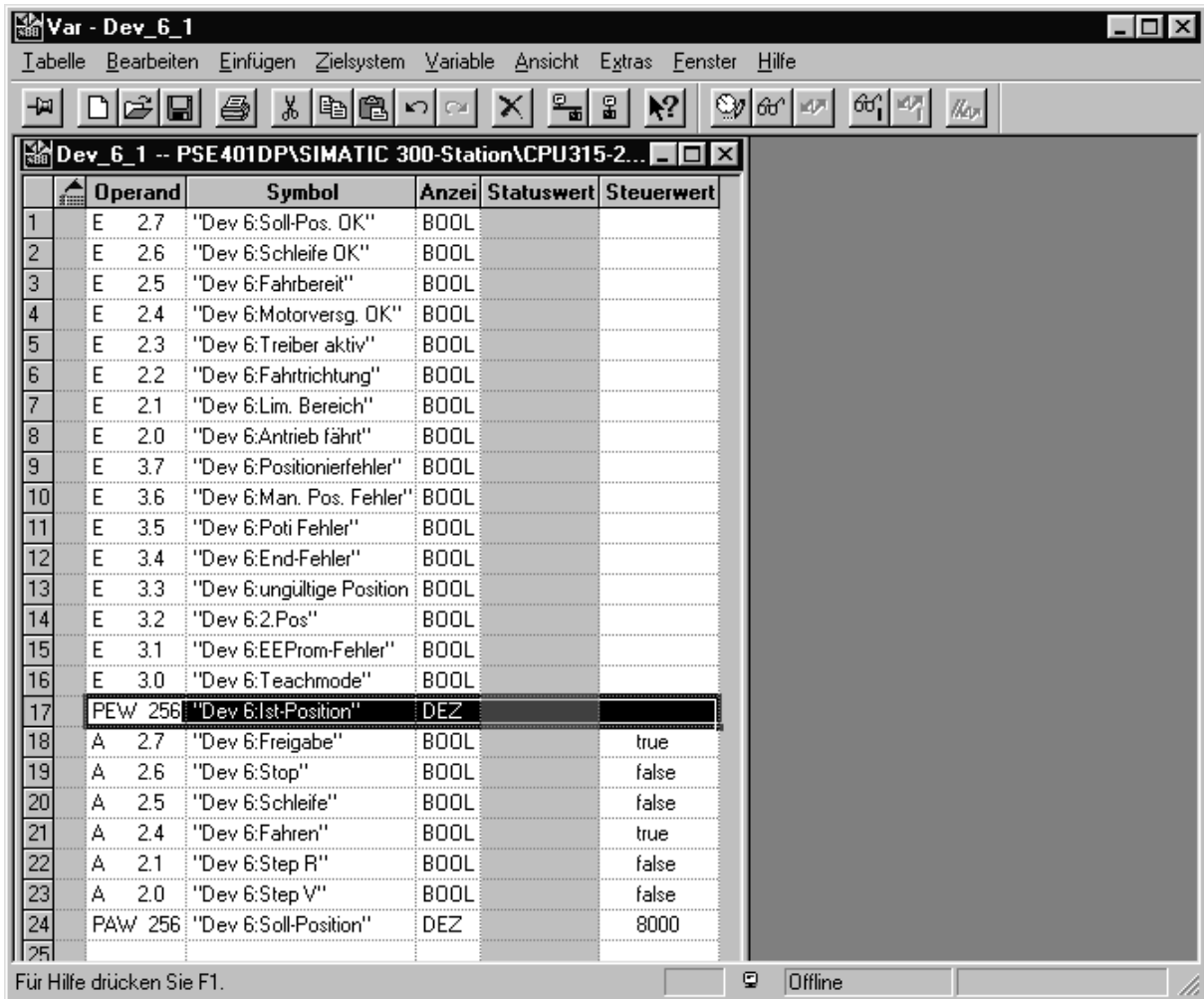

The screenshot shows the SIMATIC Manager software interface. The main window displays a table of variable declarations for 'Dev\_6\_1'. The table has five columns: 'Operand', 'Symbol', 'Anzei', 'Statuswert', and 'Steuerwert'. The rows are numbered 1 to 25. Row 17 is highlighted, showing the declaration for 'Dev 6:Ist-Position' with operand 'PEW 256', symbol 'Dev 6:Ist-Position', and data type 'DEZ'. The status value is empty and the control value is empty. Row 18 shows 'Dev 6:Freigabe' with operand 'A 2.7', symbol 'Dev 6:Freigabe', data type 'BOOL', status value empty, and control value 'true'. Row 19 shows 'Dev 6:Stop' with operand 'A 2.6', symbol 'Dev 6:Stop', data type 'BOOL', status value empty, and control value 'false'. Row 20 shows 'Dev 6:Schleife' with operand 'A 2.5', symbol 'Dev 6:Schleife', data type 'BOOL', status value empty, and control value 'false'. Row 21 shows 'Dev 6:Fahren' with operand 'A 2.4', symbol 'Dev 6:Fahren', data type 'BOOL', status value empty, and control value 'true'. Row 22 shows 'Dev 6:Step R' with operand 'A 2.1', symbol 'Dev 6:Step R', data type 'BOOL', status value empty, and control value 'false'. Row 23 shows 'Dev 6:Step V' with operand 'A 2.0', symbol 'Dev 6:Step V', data type 'BOOL', status value empty, and control value 'false'. Row 24 shows 'Dev 6:Soll-Position' with operand 'PAW 256', symbol 'Dev 6:Soll-Position', data type 'DEZ', status value empty, and control value '8000'. Row 25 is empty.

	Operand	Symbol	Anzei	Statuswert	Steuerwert
1	E 2.7	"Dev 6:Soll-Pos. OK"	BOOL		
2	E 2.6	"Dev 6:Schleife OK"	BOOL		
3	E 2.5	"Dev 6:Fahrbereit"	BOOL		
4	E 2.4	"Dev 6:Motorversg. OK"	BOOL		
5	E 2.3	"Dev 6:Treiber aktiv"	BOOL		
6	E 2.2	"Dev 6:Fahrtrichtung"	BOOL		
7	E 2.1	"Dev 6:Lim. Bereich"	BOOL		
8	E 2.0	"Dev 6:Antrieb fährt"	BOOL		
9	E 3.7	"Dev 6:Positionierfehler"	BOOL		
10	E 3.6	"Dev 6:Man. Pos. Fehler"	BOOL		
11	E 3.5	"Dev 6:Poti Fehler"	BOOL		
12	E 3.4	"Dev 6:End-Fehler"	BOOL		
13	E 3.3	"Dev 6:ungültige Position"	BOOL		
14	E 3.2	"Dev 6:2.Pos"	BOOL		
15	E 3.1	"Dev 6:EEProm-Fehler"	BOOL		
16	E 3.0	"Dev 6:Teachmode"	BOOL		
17	PEW 256	"Dev 6:Ist-Position"	DEZ		
18	A 2.7	"Dev 6:Freigabe"	BOOL		true
19	A 2.6	"Dev 6:Stop"	BOOL		false
20	A 2.5	"Dev 6:Schleife"	BOOL		false
21	A 2.4	"Dev 6:Fahren"	BOOL		true
22	A 2.1	"Dev 6:Step R"	BOOL		false
23	A 2.0	"Dev 6:Step V"	BOOL		false
24	PAW 256	"Dev 6:Soll-Position"	DEZ		8000
25					

This module transfers the current actual position to the control unit in one of two different data formats. If the spindle pitch is >4.00 mm, the limited range of values restricts the positioning options. These restrictions are not an issue for the actual position module (I32).



### 3.3 Command byte

	Operand	Symbol	Anzei	Statuswert	Steuerwert
1	E 2.7	"Dev 6:Soll-Pos. OK"	BOOL		
2	E 2.6	"Dev 6:Schleife OK"	BOOL		
3	E 2.5	"Dev 6:Fahrbereit"	BOOL		
4	E 2.4	"Dev 6:Motorversg. OK"	BOOL		
5	E 2.3	"Dev 6:Treiber aktiv"	BOOL		
6	E 2.2	"Dev 6:Fahrtrichtung"	BOOL		
7	E 2.1	"Dev 6:Lim. Bereich"	BOOL		
8	E 2.0	"Dev 6:Antrieb fährt"	BOOL		
9	E 3.7	"Dev 6:Positionierfehler"	BOOL		
10	E 3.6	"Dev 6:Man. Pos. Fehler"	BOOL		
11	E 3.5	"Dev 6:Poti Fehler"	BOOL		
12	E 3.4	"Dev 6:End-Fehler"	BOOL		
13	E 3.3	"Dev 6:ungültige Position"	BOOL		
14	E 3.2	"Dev 6:2.Pos"	BOOL		
15	E 3.1	"Dev 6:EEProm-Fehler"	BOOL		
16	E 3.0	"Dev 6:Teachmode"	BOOL		
17	PEW 256	"Dev 6:Ist-Position"	DEZ		
18	A 2.7	"Dev 6:Freigabe"	BOOL		true
19	A 2.6	"Dev 6:Stop"	BOOL		false
20	A 2.5	"Dev 6:Schleife"	BOOL		false
21	A 2.4	"Dev 6:Fahren"	BOOL		true
22	A 2.1	"Dev 6:Step R"	BOOL		false
23	A 2.0	"Dev 6:Step V"	BOOL		false
24	PAW 256	"Dev 6:Soll-Position"	DEZ		8000
25					

#### Bit 7: Release

This bit must be set for every run. If it is deleted, the current positioning run is immediately ended, the reference position is lost and a new reference run needs to be performed before beginning a new run.

#### Bit 6: Stop

If this bit is activated, all run sequences will be stopped. The drive shuts down along with the ramp, but retains the current position. No new runs may be started until this bit has been deleted.

#### Bit 5: Loop

This bit starts the reference loop. The drive uses the reference loop to determine the current actual position by completing just over one half of one rotation in the direction opposite that of travel and then returning to its original position. This function only needs to be performed after switching on the instrument or after a positioning error.

#### Bit 4: Run

This bit initiates movement toward the most recently entered target position.

**Bit 3: Assign actual value**

The set target position is assigned to the drive as the actual position. The drive then compares the position with the one determined by its absolute value encoder. If the instrument detects an overly large discrepancy, then it will set the “Positioning error” and “Invalid position” bits in the status byte. If it accepts the position entered, it will set the “Loop OK” bit and the drive will run as normal. After the initial run, the drive checks the position and performs a second positioning run if necessary.

**Bit 2: Extra; no function****Bit 1: Step R**

This bit allows the drive to move one increment in the direction opposite that of rotation. If the bit remains set, the drive will begin moving at its original speed after approx. 200 ms. This process ends as soon as the bit is deleted. Please note that increments are not exactly 1/100 mm and that this type of run does not eliminate gear backlash. If the aim is to teach the instrument a precise positioning sequence, it is important to note that the instrument will always move toward the position in the forward direction, because the gear backlash would otherwise be disruptive.

**Bit 0: Step V**

The function of this bit corresponds to that of the “Step R” bit, except that, in this case, movement is in the direction of rotation.

**3.4 Target position**

This module transfers the target position to the PSE 4xxDP. Two different modules, which differ in terms of the length of the transferred data byte, are available for transferring the target position. The target position module (I16) will no longer be able to reach all positions in the range when the spindle pitch is > 4.00 mm.

## 4 Setting parameters

Setting parameters makes it possible to adapt the instruments to the task at hand. The following parameters are available:

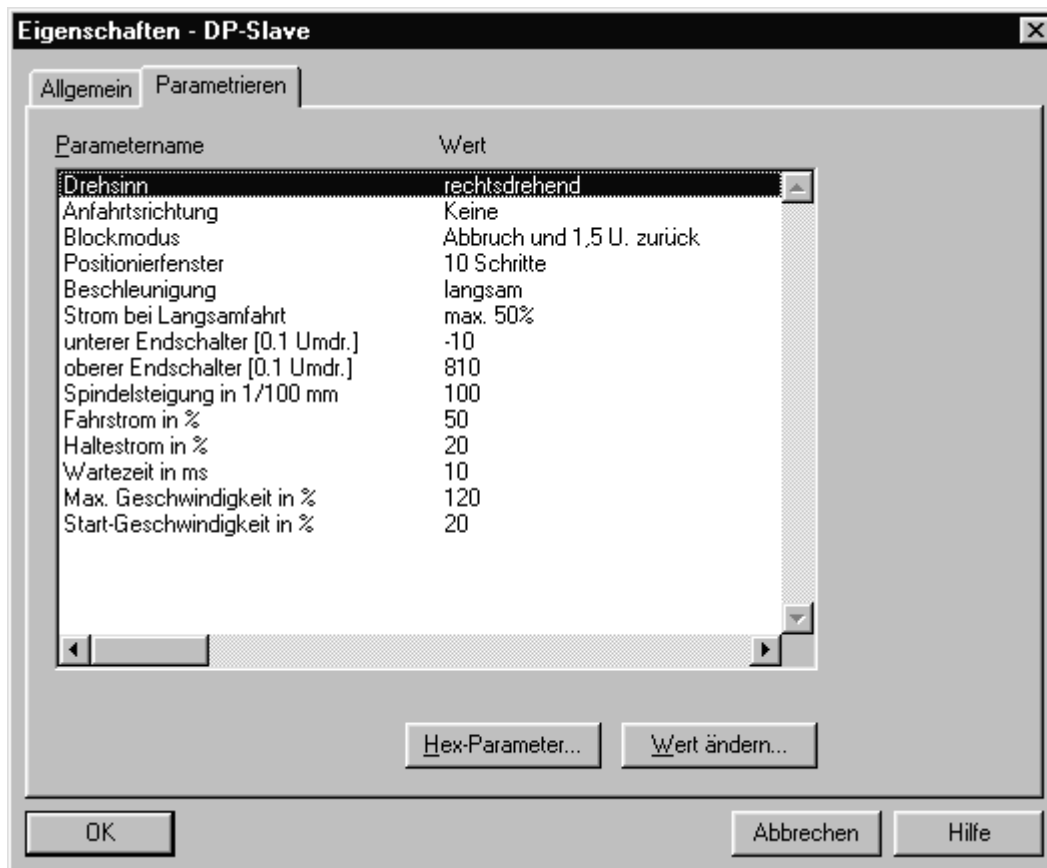

### 4.1 Direction of rotation:

This parameter specifies the direction in which the output shaft rotates for positive changes to target values.

### 4.2 Direction of travel:

This parameter is used for stipulating the direction in which gear backlash will play out.

### 4.3 Block mode:

This parameter specifies how the instrument will respond when the drive is blocked. In such a case, the drive will either stop immediately or will automatically turn 1.5 rotations in the direction opposite that of travel.

#### **4.4 Positioning window**

This allows the operator to input increments for the maximum allowable difference between the position of the stepping motor and the position determined by the absolute measuring system. The positioning window is increased by a factor of 2 for runs with no reference loop. The maximum discrepancy in the drive shaft depends on the number of increments/rotations. This value can be found in the table given in the "Technical data" section.

#### **4.5 Acceleration:**

This parameter allows the user to lengthen the acceleration ramp for cases of high torque or moment of inertia. This does not affect the deceleration ramp.

#### **4.6 Max. motor current:**

This parameter influences the reduction in current needed for slow runs such as manual runs or reference loops. Ordinarily, the current is limited to no more than 50% of the maximum possible motor current, because the motor torque will still be fairly large at reduced speeds. Problems may arise near the limits, however, in which case this parameter can be used to increase the current for these runs to the preset operating current.

#### **4.7 Lower limit switch:**

This parameter stipulates the smallest position that can be achieved. Target positions below this value are not accepted. Once this limit has been exceeded, the drive is automatically stopped and the corresponding bit in the status byte is activated. Values should be entered in 1/10 rotations.

#### **4.8 Upper limit switch:**

This parameter stipulates the largest position that can be achieved. Target positions above this value are not accepted. Once this limit has been exceeded, the drive is automatically stopped and the corresponding bit in the status byte is activated. Values should be entered in 1/10 rotations.

#### **4.9 Operating current:**

This parameter stipulates the amount of current and thus the torque developed when the drive system is operating.

**4.10 Holding current:**

This parameter stipulates the amount of current and thus the torque developed when the drive system is on standstill. When on system standstill, the output drivers are switched off when the holding current is 0.

**4.11 Idle period:**

This parameter specifies (in min.) the minimum idle period required between two positioning runs of differing torque.

**4.12 Spindle pitch:**

This parameter stipulates how many 1/100 mm are moved per rotation.

**4.13 Max. speed:**

This parameter stipulates the maximum run speed. Reducing run speed can have a positive effect on torque; specified torques of 1 Nm or 5 Nm, for instance, can only be guaranteed at speeds below 100%. Torque is reduced at speeds of over 100%.

**4.14 Starting speed:**

This parameter specifies the minimum speed at which the drive can operate. This speed is the same as the acceleration ramp speed, the speed of the reference loop and the speed of an individual increment.

## 5 Programming tips

The following sequence should be retained when writing the positioning program:

1. Transfer the target position.
2. Wait until the “Target position OK” bit has been reset.
3. The “Run” bit can now be set.
4. The drive starts up and sets the “Drive running” bit.
5. The “Run” bit can now be deleted.
6. The program waits until the “Target position OK” bit is set and the “Drive running” bit is deleted (only if the “Run” bit has been deleted).

If the target position and the “Run“ bit are set at the same time, the “Run” bit must be set for at least 50 ms to ensure that the drive will recognize it. The query for the “Drive running” bit can cause the “Run” bit to be processed incorrectly.

## 6 Technical data

for the PSE 40xDP:

<b>Ambient conditions</b>	
ambient temperature	0 °C to +45 °C
storage temperature	-10 °C to +70 °C
shock resistance as stipulated in DIN IEC 68-2-27	50 g 11 ms
resistance to vibration as stipulated in DIN IEC 68-2-6	10 Hz to 55 Hz 1.5 mm 55 Hz to 1000 Hz 10 g 10 Hz to 2000 Hz 5 g
EMC standards	CE
conformity	 declaration of conformity available upon request
protection class	IP 54
<b>Electrical data</b>	
nominal power output:	10 W (25 % OT)
power consumption	max. 36 W
supply voltage	24 VDC ± 20 %
nominal current	1.5 A
no-load current	1.0 A
positioning resolution	0,18°
positioning accuracy	0,9°
DP protocol	Profibus DP (Siemens) with galvanic separation
max. baud rate	9.6 kbaud to 12 Mbaud
absolute value acquisition	by means of a precision potentiometer; novel method for calculating absolute position from potentiometer value.
<b>Physical data</b>	
positioning range	80 revolutions of the output shaft yields 160 mm run distance (max.) at a spindle pitch of 2 mm
nominal torque:	1 Nm (model: 401) 1.8 Nm (model: 402) 5 Nm (model: 405)
self-holding torque (w/ current 100% OT)	1 Nm (model: 401) 1.8 Nm (model: 402) 5 Nm (model: 405)
self-holding torque (no current)	10 Ncm (model: 401) 18 Ncm (model: 402) 50 Ncm (model: 405)
nominal rated speed:	78 rpm (model: 401) 45 rpm (model: 402) 15 rpm (model: 405)
torsional rigidity (angle of rotation when switching from operation w/o backlasht to maximum torque)	max. 0.2°

gear backlash (no spindle offsetrun)	max. 0.5°
spindle offset	automatic; each new position is always approached from the same direction
output shaft	14 h 7 hollow shaft with adjustable collar
resolution	0.01 mm for spindle pitches of 1 mm, 2 mm, 4 mm, 5 mm (= 100 / 200 / 400 / 500 increments per revolution) physical: 2000 increments per revolution (model: 401) physical: 10000 increments per revolution (model: 405)
maximum radial force	150 N
maximum axial force	80 N
dimensions (l x w x h)	70 x 56 x 145 mm
weight	1,300 g



PSE 41xDP:

<b>Ambient conditions</b>	
ambient temperature	0 °C to +45 °C
storage temperature	-10 °C to +70 °C
shock resistance as stipulated in DIN IEC 68-2-27	50 g 11 ms
resistance to vibration as stipulated in DIN IEC 68-2-6	10 Hz to 55 Hz 1.5 mm 55 Hz to 1000 Hz 10 g 10 Hz to 2000 Hz 5 g
EMC standards	CE
conformity	 declaration of conformity available upon request
protection class	IP 54
<b>Electrical data</b>	
nominal power output:	10 W (25 % OT)
power consumption	max. 36 W
supply voltage	24 VDC ± 20 %
nominal current	1.5 A
no-load current	1.0 A
positioning resolution	0,18°
positioning accuracy	0,9°
DP protocol	Profibus DP (Siemens) with galvanic separation
max. baud rate	9.6 kbaud to 12 Mbaud
absolute value acquisition	by means of a precision potentiometer; novel method for calculating absolute position from potentiometer value.
<b>Physical data</b>	
positioning range	80 revolutions of the output shaft yields 160 mm run distance (max.) at a spindle pitch of 2 mm
nominal torque:	1 Nm (model: 411) 5 Nm (model: 415)
self-holding torque (w/ current 100% OT)	1 Nm (model: 411) 5 Nm (model: 415)
self-holding torque (no current)	10 Ncm (model: 411) 50 Ncm (model: 415)
nominal rated speed:	78 rpm (model: 411) 15 rpm (model: 415)
torsional rigidity (angle of rotation when switching from operation w/o backlash to maximum torque)	max. 0,2°
gear backlash (no spindle offset run)	max. 0.5°
spindle offset	automatic; each new position is always approached from the same direction

output shaft	14 h 7 hollow shaft with adjustable collar
resolution	0.01 mm for spindle pitches of 1 mm, 2 mm, 4 mm, 5 mm (= 100 / 200 / 400 / 500 increments per revolution) physical: 2000 increments per revolution (model: 411) physical: 10000 increments per revolution (model: 415)
maximum radial force	150 N
maximum axial force	80 N
dimensions (l x w x h)	70 x 56 x 145 mm
weight	1,000 g

for the PSE 42xDP:

<b>Ambient conditions</b>	
ambient temperature	0 °C to +45 °C
storage temperature	-10 °C to +70 °C
shock resistance as stipulated in DIN IEC 68-2-27	50 g 11 ms
resistance to vibration as stipulated in DIN IEC 68-2-6	10 Hz to 55 Hz 1.5 mm 55 Hz to 1000 Hz 10 g 10 Hz to 2000 Hz 5 g
EMC standards	CE
conformity	 declaration of conformity available upon request
protection class	IP 54
<b>Electrical data</b>	
nominal power output:	24 W (25 % OT)
power consumption	max. 70 W
supply voltage	24 VDC ± 20 %
nominal current	3 A
no-load current	1.5 A
positioning resolution	0,18°
positioning accuracy	0,9°
DP protocol	Profibus DP (Siemens) with galvanic separation
max. baud rate	9.6 kbaud to 12 Mbaud
absolute value acquisition	by means of a precision potentiometer; novel method for calculating absolute position from potentiometer value.
<b>Physical data</b>	
positioning range	80 revolutions of the output shaft yields 160 mm run distance (max.) at a spindle pitch of 2 mm
nominal torque:	3 Nm (model: 423) 5 Nm (model: 425) 10 Nm (model: 4210) 25 Nm (model: 4225)
self-holding torque (w/ current 100% OT)	3 Nm (model: 423) 5 Nm (model: 425) 10 Nm (model: 4210) 25 Nm (model: 4225)
self-holding torque (no current)	30 Ncm (model: 423) 50 Ncm (model: 425) 100 Ncm (model: 4210) 250 Ncm (model: 4225)
nominal rated speed:	75 rpm (model: 423) 38 rpm (model: 425) 19 rpm (model: 4210) 9 rpm (model: 4225)
torsional rigidity (angle of rotation when switching from operation w/o backlash to maximum torque)	max. 0.2°

gear backlash (no spindle offset run)	max. 0.5°
spindle offset	automatic; each new position is always approached from the same direction
output shaft	14 h 7 hollow shaft with adjustable collar (models 423 and 425) 14 h 7 hollow shaft with adjustable collar and feather key (models 4210 and 4225)
resolution	0.01 mm for spindle pitches of 1 mm, 2 mm, 4 mm, 5 mm (= 100 / 200 / 400 / 500 increments per revolution) physical: 8200 increments per revolution (model: 4210)
maximum radial force	150 N
maximum axial force	80 N
dimensions (l x w x h)	135 x 56 x 86 mm
weight	1,900 g (model: 4210)
optional	holding brake

for the PSE 43xDP:

<b>Ambient conditions</b>	
ambient temperature	0 °C to +45 °C
storage temperature	-10 °C to +70 °C
shock resistance as stipulated in DIN IEC 68-2-27	50 g 11 ms
resistance to vibration as stipulated in DIN IEC 68-2-6	10 Hz to 55 Hz 1.5 mm 55 Hz to 1000 Hz 10 g 10 Hz to 2000 Hz 5 g
EMC standards	CE
conformity	 declaration of conformity available upon request
protection class	IP 54
<b>Electrical data</b>	
nominal power output:	24 W (25 % OT)
power consumption	max. 70 W
supply voltage	24 VDC ± 20 %
nominal current	3 A
no-load current	1.5 A
positioning resolution	0,18°
positioning accuracy	0,9°
DP protocol	Profibus DP (Siemens) with galvanic separation
max. baud rate	9.6 kbaud to 12 Mbaud
absolute value acquisition	by means of a precision potentiometer; novel method for calculating absolute position from potentiometer value.
<b>Physical data</b>	
positioning range	80 revolutions of the output shaft yields 160 mm run distance (max.) at a spindle pitch of 2 mm
nominal torque:	3 Nm (model: 433) 10 Nm (model: 4310) 25 Nm (model: 4325)
self-holding torque (w/ current 100% OT)	3 Nm (model: 433) 10 Nm (model: 4310) 25 Nm (model: 4325)
self-holding torque (no current)	30 Ncm (model: 433) 100 Ncm (model: 4310) 250 Ncm (model: 4325)
nominal rated speed	78 rpm (model: 433) 19 rpm (model: 4310) 9 rpm (model: 4325)
torsional rigidity (angle of rotation when switching from operation w/o backlash to maximum torque)	max. 0.2°
gear backlash (no spindle offset run)	max. 0.5°
spindle offset	automatic; each new position is always approached from the same direction

output shaft	14 h 7 hollow shaft with adjustable collar (model 433) 14 h 7 hollow shaft with adjustable collar and feather key (models 4310 and 4325)
resolution	0.01 mm for spindle pitches of 1 mm, 2 mm, 4 mm, 5 mm (= 100 / 200 / 400 / 500 increments per revolution) physical: 2000 increments per revolution (model: 433)
maximum radial force	150 N
maximum axial force	80 N
dimensions (l x w x h)	85 x 60 x 160 mm
weight	1,700 g (model: 433)
optional	holding brake

# 8 Dimension drawings

## PSE401/402/405DP

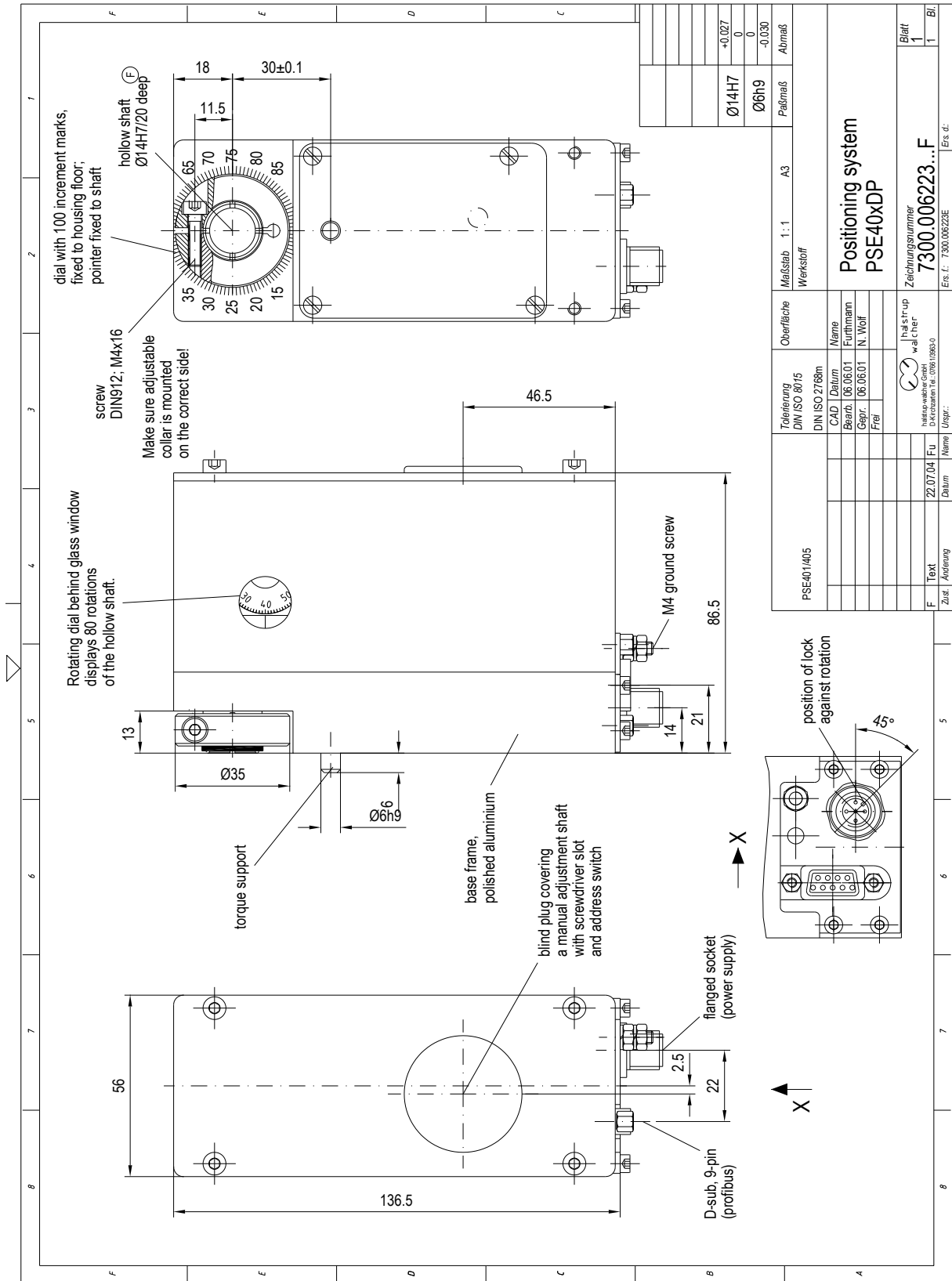

PSE401/405	Tolerierung DIN ISO 8015	Oberfläche	Maßstab	A3	Blatt	1
	DIN ISO 2768m	Werkstoff				
	CAD Datum	Name				
	Bearb. 06.06.01	Furtmann				
	Gepr. 06.06.01	N. Wolf				
	Frei					
Positioning system PSE40xDP			Zeichnungsnummer 7300.006223...F			
F Text			Blatt			
Zus. Änderung			1			
Datum 22.07.04			1			
Name			Blatt			
Urspr. 7300.006223E			1			
Ers. d.						

PSE411/415DP

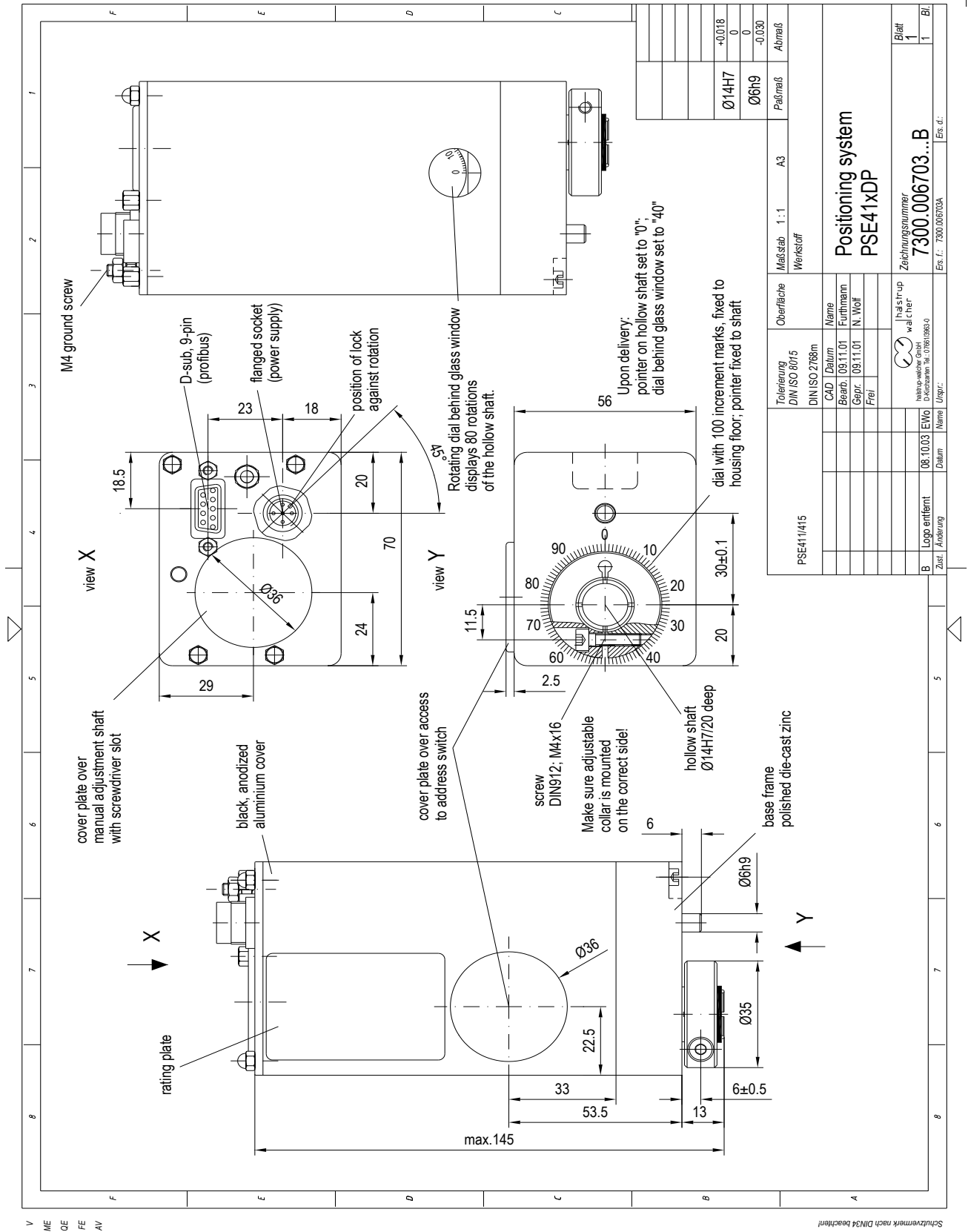

Upon delivery:  
pointer on hollow shaft set to "0",  
dial behind glass window set to "40"

Tolerierung DIN ISO 8015	Oberfläche Verkstoff	Maßstab	1:1	A3
		CAD	Datum	Name
		Bearb.	09.11.01	Fürmann
		Gepr.	09.11.01	N. Wolf
PSE411/415				
Positioning system PSE41xDP				
Zeichnungsnummer 7300.006703...B				
Ers. f.: 7300.006703A				

B	Logo entfernt	08.10.03	EVO	Name	Ungpr.
	Zust.	Änderung	Datum		
Ers. d.:					

Schutzemerk nach DIN34 beachtet!



PSE423DP

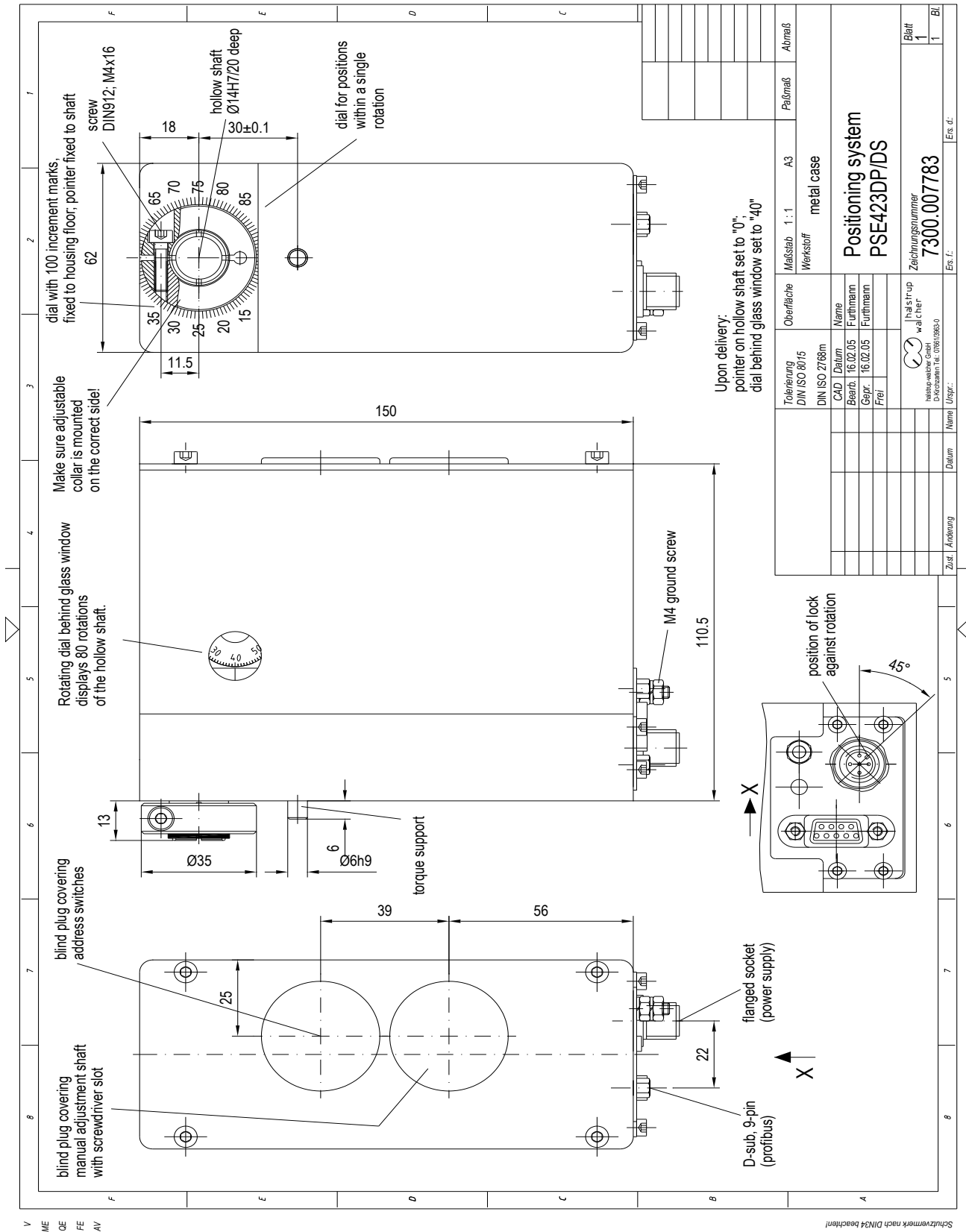

Upon delivery, pointer on hollow shaft set to "0", dial behind glass window set to "40"

Teilzeichnung DIN ISO 80/15	Oberfläche Maßstab 1:1	A3	Abmaß
DIN ISO 2768m	Werkstoff	metal case	
CAD Datum	Name		
Bearb. 16.02.05	Furthmann		
Gepr. 16.02.05	Furthmann		
Frei			
Name		Blatt	
Zust. Änderung		1	
Datum		1	
Name		Ers. d.	
Name Urspr.		Blatt	
Zeichnungsnummer		1	
7300.007783		Blatt	
Ers. d.		1	
Blatt		1	
Blatt		1	

Schutzmerk nach DIN4 beachten!

PSE425/4210/4225DP

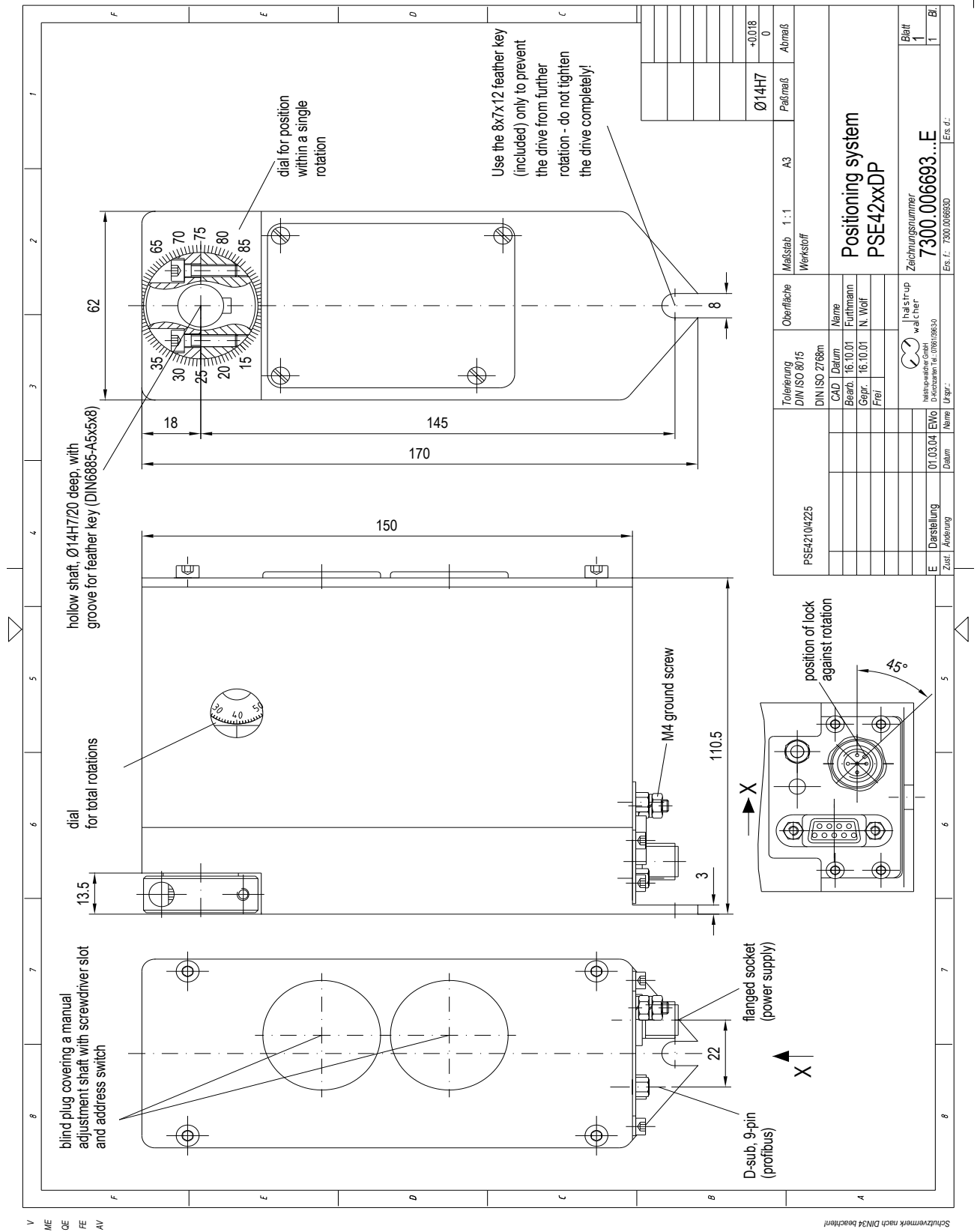

PSE42/04225		Tolerierung DIN ISO 8015		Maßstab 1:1		A3	
		DIN ISO 2768m		Oberfläche		Arbeitsstoff	
		CAD Datum		Name		Positioning system	
		Bearb. 16.10.01		Furtmann		PSE42xxDP	
		Gepr. 16.10.01		N. Wolf		Zeichnungsnummer	
		Frei				7300.006693...E	
				halstrup walcher		Ers. Nr.: 7300.006693D	
E Darstellung		01.03.04 EW/vo		halstrup walcher		Blatt	
Zust Änderung		Dateiname: 0705106830		Dateiname: 0705106830		1	
		Datum		Name / Unger.		1	
						Bl	

V ME OE FE AV

Schutzvermerk nach DIN34 beachten!

PSE43xDP

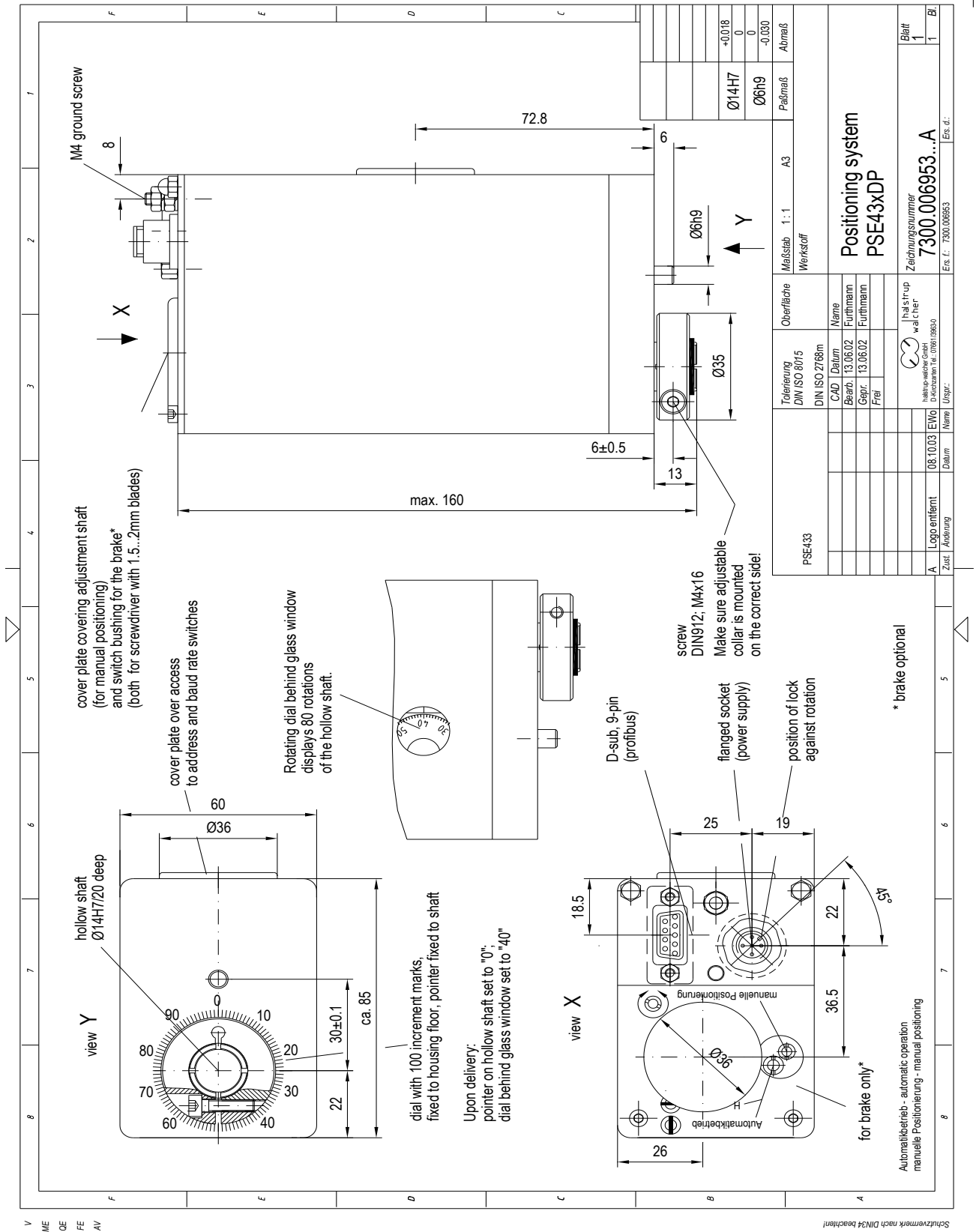

Schutzvermerk nach DIN34 beachten!

PSE4310/4325DP

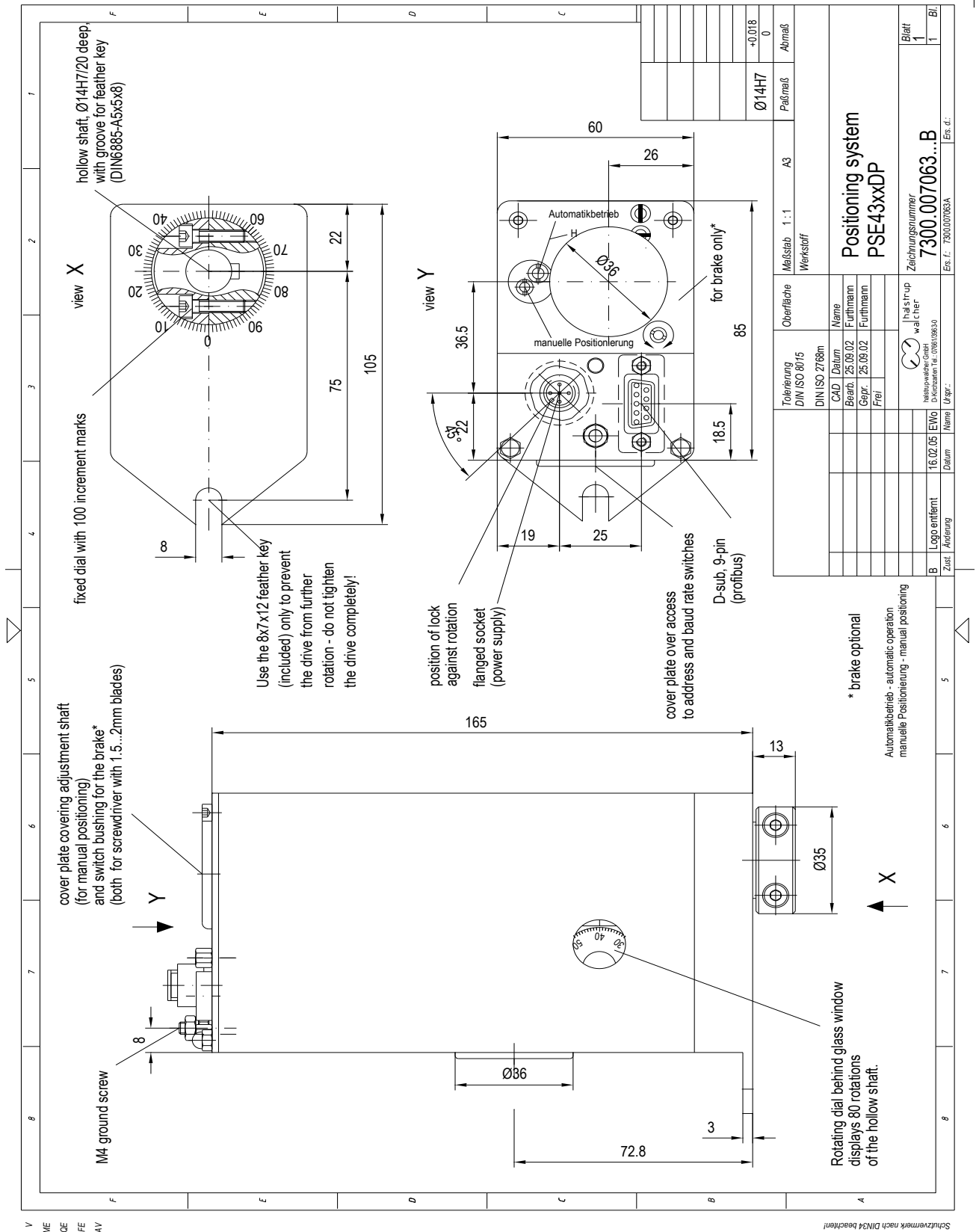

Tolerierung DIN ISO 2768m		Oberfläche Metzstab 1:1 A3		Werkstoff Abmaß Ø14H7 +0.018 0	
CAD	Datum	Name		Blatt	
Bearb.	25.09.02	Furtmann		1	
Gepr.	25.09.02	Furtmann		1	
Frei				Blatt	
Logo entfernt			Zeichnungsnummer		
16.02.05 E/W6			7300.007063...B		
Zust. Änderung			Ers. d.		
Datum			Urspr.		
16.02.05			7300007063A		

Positioning system  
PSE43xxDP

halstrup walcher  
halstrup walcher GmbH  
D-30924 Hannover

Automatikbetrieb - automatic operation  
manuelle Positionierung - manual positioning

\* brake optional

Rotating dial behind glass window displays 80 rotations of the hollow shaft.

7100.003624B\_PSE4xxdp\_eng.doc 22.08.14 Sie/Ze